

eXtra4<winIII> Software for Label Printing

Industry-specific labelling for jewellery and watches

Get started immediately with label printing – without time-consuming label design.

That quickly you get to the ready-printed label: Simply type in data into a ready-to-use label layout and print it. You choose the design you want instead of having to create it yourself. No need to define input fields, font sizes, line spacing and barcode parameters! More than 1,000 different layouts are provided in the software for over 400 label shapes. The label design has already been done for you by eXtra4<winIII>.

- Ready-made label designs for maximum data volume with optimum readability
- Automated generation of barcode and matrix code
- Integrated database for item and address management
- Printing of single labels without label loss by printer's feed after each print job
- Help function with step-by-step instructions
- Start-up assistance included via online support for all editions subject to a charge
- Approved since 20 years in jewellery and watch industry
- Several thousand highly satisfied users worldwide



Due to the general cost situation, we can no more keep our prices constant over a longer period of time, but have to permanently adjust them to the supply market. Please find up-to-date prices in our online shop.

www.extra4shop.de

extra4software.de

eXtra4<winIII> The software core function: label printing

Label printing is the key function of eXtra4<winIII>. All seven software editions fulfil this task and deliver label printing of the same high quality. The only differences are in the scope of services. The ease of use, on the other hand, is the same across all editions. These features support the user in label printing:

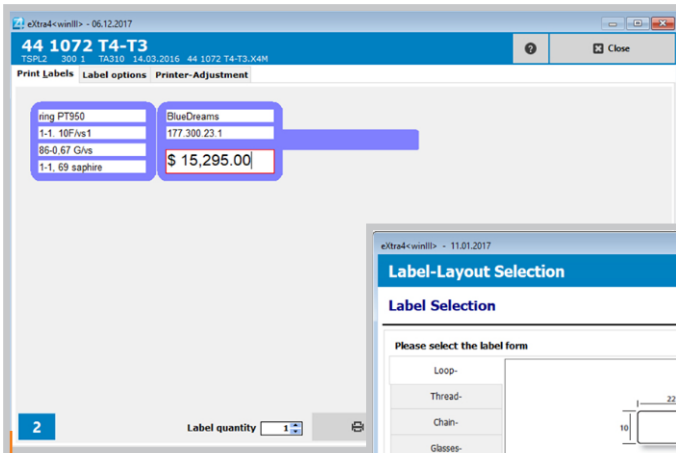

Type'n Print – Straight to print
The ready-to-use label designs are activated as a layout for the desired label shape. They contain the entry fields where a user enters the data to be printed on the label.

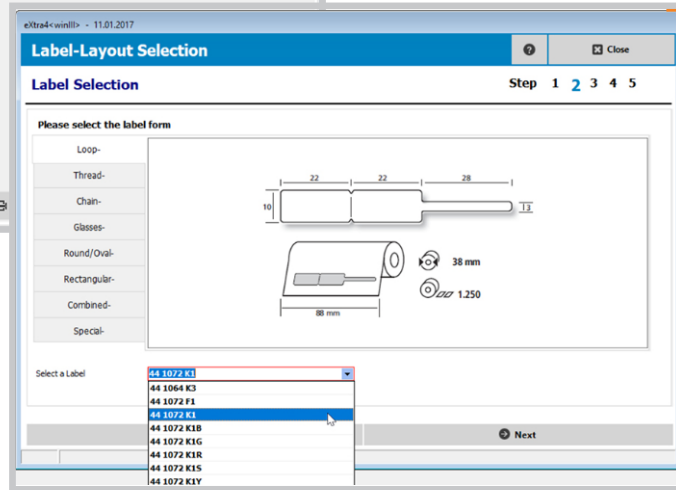

The Label/Layout Assistan
Precision is guaranteed when printing labels with eXtra4<winIII> without users having to do anything themselves. The basis for this are predefined label designs. When selecting them, the label/layout assistant ensures that only designs are suggested to the user that fit the desired label and can be processed by the stored printer model.

Predefined text as label content
Filling entry fields without typing can be done with text presets. As soon as the label layout is called up for data entry, the entry mask appears with already filled in entry fields. The stored text only needs to be corrected in details, e.g. data for weight and height.

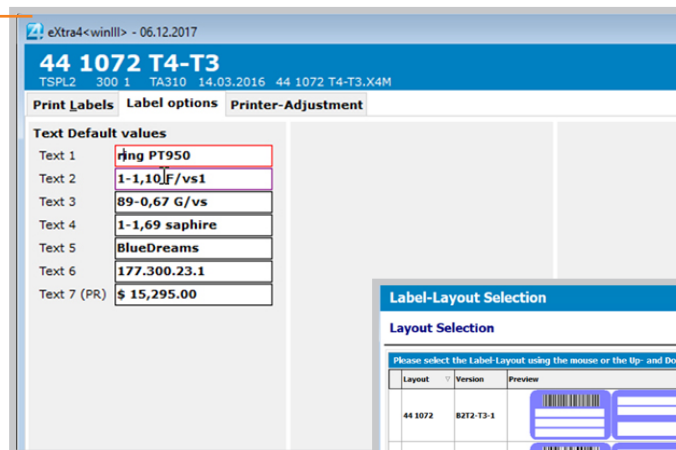

Barcode generation
eXtra4<winIII> creates a barcode or matrix code from an item number and controls its printing. Into what code an item number is converted by the software depends on its structure and the selected label layout.

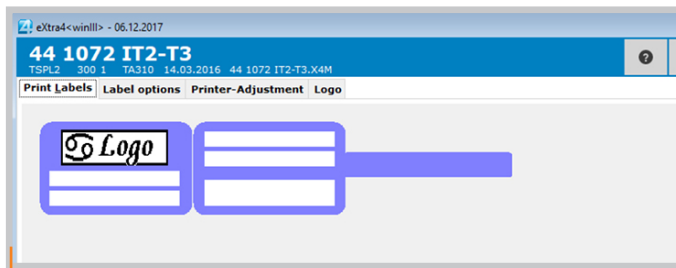
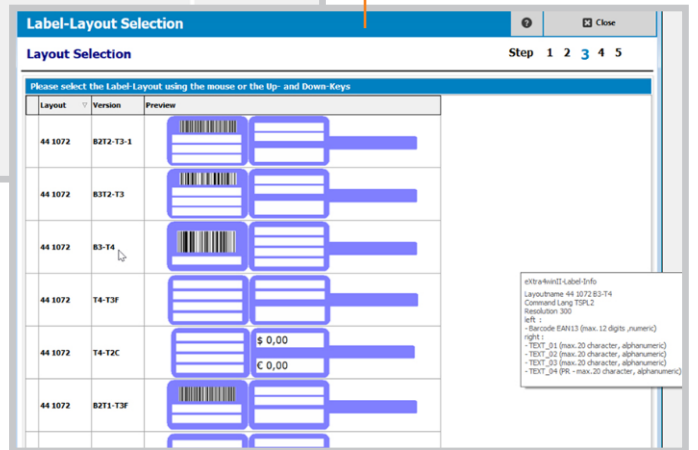

Logo printing
Users can add their own company logo to labels. The software copies the signet as a bitmap graphic into the data entry mask and transfers it permanently to the printer memory. There it is ready for printing on the label when data is printed out.

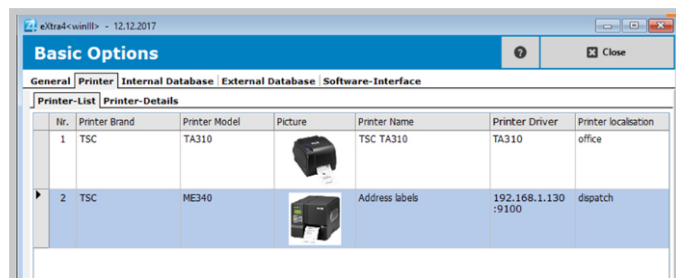

Printer management
The software carefully guides users when they connect their devices to eXtra4<winIII>. A table clearly lists all connected label printers and is the basis for subsequent printing processes.

eXtra4<winIII> Additional functions beyond label printing

The eXtra4<winIII> software has a modular design. In addition to label printing as its core, it has numerous additional functions. They are graded according to need and are available in software editions that build on one another.

Item management

Instead of entering data for the label of an item again and again, the item with all its characteristics is created as a data record in the database integrated in the software. Details for label printing can now be read out there again and again. The item number serves as a search key. It can be generated automatically by eXtra4<winIII> via item groups.

In Edition "Basic", there is space in memo texts for item data beyond the information for the label. A small product image (thumb-nail) can also be stored.

From "Advanced" edition onwards, eXtra4<winIII> supplements the item management with stock levels and storage locations. Barcode can be used to control goods movements. The software enables an evaluation of master data via lists, their printing via a report generator and an inventory.

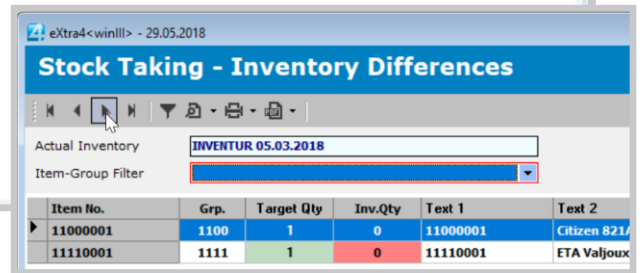
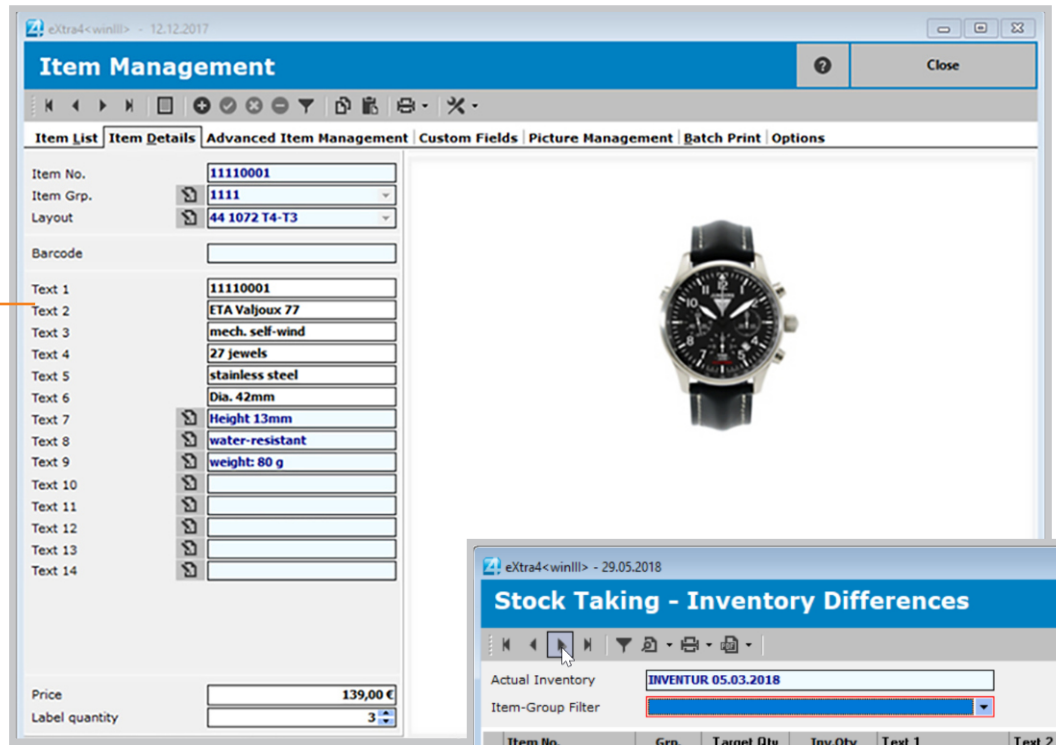

Picture management

For the management of an image pool, eXtra4<winIII> links items with an unlimited number of image files in high resolution of current cameras. This makes it easier to search for and combine a selection of images and to send them via address management data.

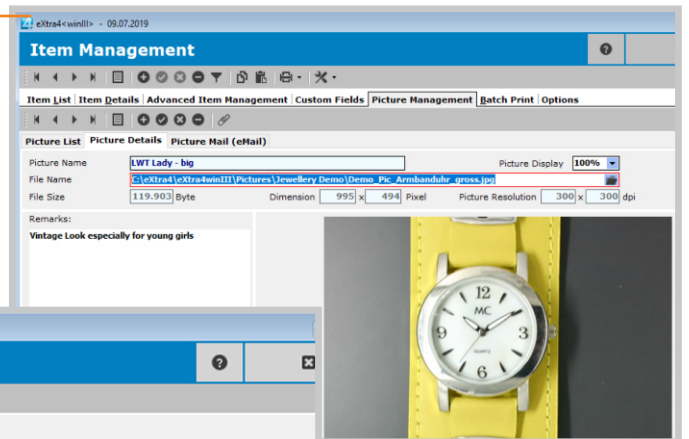

Address management

For printing dispatch labels, eXtra4<winIII> manages addresses under a unique code, e.g. the customer or supplier number. Categorisation allows the data to be sorted according to suppliers, customers and other criteria.

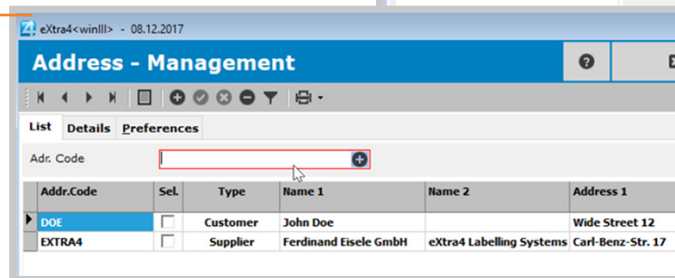

Integrated database

Depending on the edition, the database is designed locally as a single-user solution or as a server for a multi-user solution.

The software eXtra4<winIII> is able to access many third-party databases directly. In this case, data transfer via export/import is not necessary for label printing.

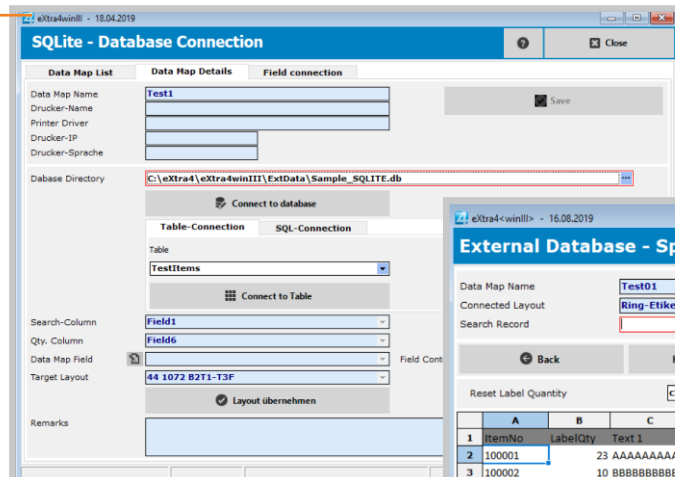

Data export in Excel format

The software delivers selected data in an .xls file or .xlsx file, where they can be conveniently edited and compiled into lists.

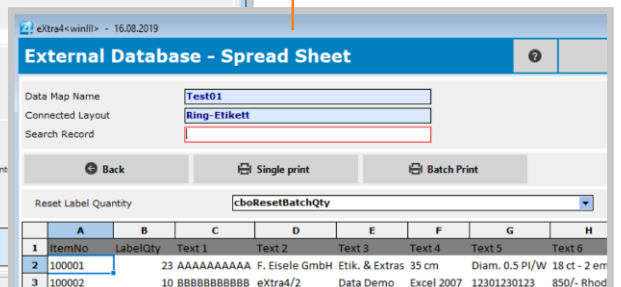

eXtra4<winIII> Software – editions and prices

Editions	Ultra Lite	Lite	Basic	Advanced	Advanced Connect	Small Business**	Business**
Label Printing	■	■	■	■	■	■	■
Printers – Number	1	1	2	4	4	4	∞
Layouts – Number	1	4	12	∞	∞	∞	∞
Labels – Number	1	∞	∞	∞	∞	∞	∞
Simple Administration items/ addresses			■	■	■	■	■
Advanced Administration items				■	■	■	■
Picture Management				■	■	■	■
Database Connection lokal					■	■	■
Detailed Item Features**						■	■
Process Management**						■	■
Multi-user Capability**							■
Support Units included	–	–	10	17	20	40	60
Item number	92 X4W3-UL	92 X4W3-L	92 X4W3-B	92 X4W3-A	92 X4W3-C	92 X4W3-M	92 X4W3-S
Price in € plus VAT	0,00	0,00	149,00	249,00	299,00	a. A.	a. A.

* available as beta-version ** in development

The label printing software eXtra4<winIII> is available in seven different editions. This means that every user, whether beginner, advanced or expert, can select exactly the edition with the features he/she really needs. Upgrades from one edition to the next make it possible to easily add more functions later as needed.

System requirements: Microsoft

Windows 8/10/11

Licensing

eXtra4<winIII> is available as site licence: **Buy once and use permanently**

- on any number of computers
- in the whole shop/location

Language versions

Besides German available in

- English, French
- Spanish, Italian
- Dutch, Swedish
- Greek, Russian
- Polish, Czech and more

Free trial version

at www.eXtra4.com – Request download now!

Edition „Ultra Lite“ as the simplest version of the software is available free of charge. More advanced software editions can be activated with their features at a later date or initially activated as a trial for 60 days.



34 2050

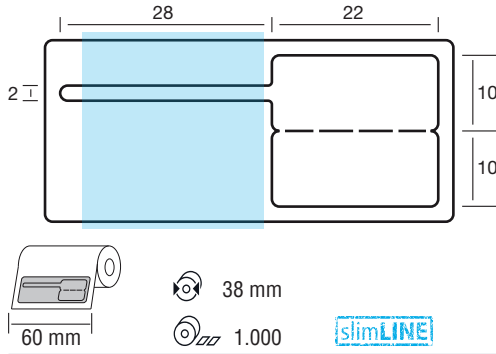

Narrow loop

34 2050IR K1

BESTSELLER

TTK-Plus, brilliant white

A1, A2, A3 81 TTK1-065Z, 81 TTK1-057Y

	1.000	3.000	5.000	10.000	20.000	30.000
€ / 1.000	52,85	48,55	44,20	37,35	31,35	28,65
€ / ☉	52,85	48,55	44,20	37,35	31,35	28,65



34 2050IR LC1

TTK-LC, brilliant white

LowCost-foil for simple applications

A1, A2, A3 81 TTK1-065Z, 81 TTK1-057Y

	2.500	5.000	10.000	20.000	30.000	50.000
€ / 1.000	34,85	31,75	28,65	26,20	23,85	21,70
€ / ☉	87,13	79,38	71,62	65,50	59,63	54,25

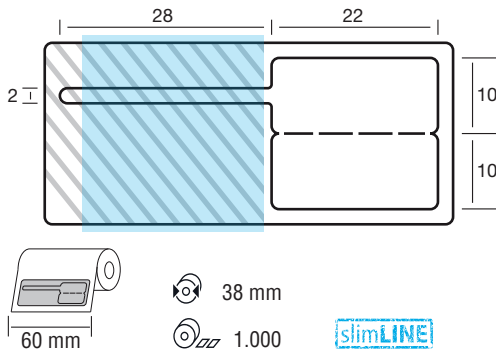

Transparent, narrow loop

34 2050IR Z1

TTK-PlusZ, brilliant white

A1, A2, A3 81 TTK1-065Z, 81 TTK1-057Y

	1.000	3.000	5.000	10.000	20.000	30.000
€ / 1.000	61,95	55,80	49,60	39,70	34,40	30,80
€ / ☉	61,95	55,80	49,60	39,70	34,40	30,80

Thermal transfer printers



61 G-RT200

Godex RT200, 200 dpi

299,00 €

3 years producer warranty (bring-in-service)

■ Exclusive from eXtra4 with online support



61 G-RT230

Godex RT230, 300 dpi

369,00 €

3 years producer warranty (bring-in-service)

■ Exclusive from eXtra4 with online support

Thermal transfer carbon ribbons

Item No.	Width (mm)	Colour	Reel core	Length (m)	from 1 pcs.	from 5 pcs.	from 10 pcs.
Quality smear resistant 81 TTW1-057Y	57	black	0,5 Zoll	74	7,50 €/Roll	7,10 €/Roll	6,70 €/Roll
Quality scratch-resistant 81 TTK1-057Y	57	black	0,5 Zoll	74	8,50 €/Roll	8,05 €/Roll	7,70 €/Roll

Scanners 1D/2D



62 A-AS9400

Argox AS-9400, USB

99,50 €

12 month producer warranty (bring-in-service)

eXtra4<winIII> Labels and hardware – selection desktop range

Labels and hardware are distributed by the brand "eXtra4 Labelling Systems" from Ferdinand Eisele GmbH.



BESTSELLER

01.04.2023

44 1072

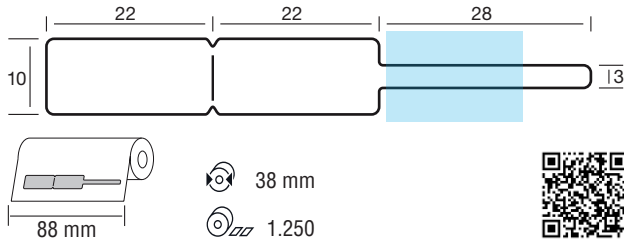

44 1072 K1

TTK-Plus, brilliant white

A1, A2 81 TTK1-110(x)

	1.250	5.000	10.000	20.000	30.000	50.000
€ / 1.000	45,20	37,30	30,55	24,70	22,75	21,15
€ / ☉	56,50	46,62	38,19	30,87	28,44	26,44

44 1072 LC1

01.04.2023

TTK-LC, brilliant white

LowCost-foil for simple applications

A1, A2 81 TTK1-110(x)



	2.500	5.000	10.000	20.000	30.000	50.000
€ / 1.000	28,45	25,10	21,30	17,95	15,50	13,30
€ / ☉	71,12	62,75	53,25	44,87	38,75	33,25

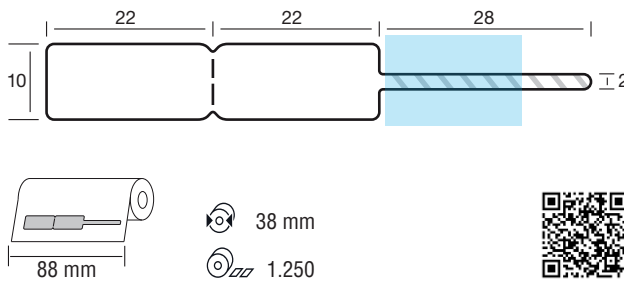

Transparent, narrow loop

44 1072 Z1

01.04.2023

TTK-PlusZ, brilliant white

A1, A2 81 TTK1-110(x)

	1.250	5.000	10.000	20.000	30.000	50.000
€ / 1.000	51,65	42,95	35,75	29,70	25,95	22,80
€ / ☉	64,56	53,69	44,69	37,12	32,44	28,50

Thermal transfer printers



61 A-O4-350

Argox O4-350M, 300 dpi

499,00 €

2 years producer warranty (bring-in-service)

■ Exclusive from eXtra4 with online support



61 A-O4-250

Argox O4-250M, 200 dpi

399,00 €

2 years producer warranty (bring-in-service)

■ Exclusive from eXtra4 with online support

Thermal transfer carbon ribbons

Item No.	Width (mm)	Colour	Reel core	Length (m)	from 1 pcs.	from 5 pcs.	from 10 pcs.
Quality smear resistant 81 TTW1-110Z	110	black	0,5 Zoll	74	9,25 €/Roll	7,95 €/Roll	6,95 €/Roll
Quality scratch resistant 81 TTK1-110Z	110	black	0,5 Zoll	74	13,20 €/Roll	12,20 €/Roll	11,35 €/Roll

As software for label printing, eXtra4<winIII> is optimally tailored to labels and hardware from eXtra4 Labelling Systems. The expertise of Ferdinand Eisele GmbH as a label manufacturer and dealer/distributor of suitable thermal transfer printers and identification code scanners ideally complements the experience of eXtra4 Software + Service GmbH from over 25 years of software development.

The eXtra4 brand combines industry expertise with technical know-how and provides labelling systems for jewellery and watches. Jewellers and goldsmiths, manufacturers and retailers alike will find industry solutions from a single source that are specially designed to meet their individual needs.

More choice
in the catalogue at www.extra4.com



Order right away
in the webshop at www.extra4shop.de



More products see current catalogue, webshop and on request. All prices plus VAT.

eXtra4 Software + Service GmbH | Carl-Benz-Str. 17 | 75217 Birkenfeld/Germany | Tel. +49 7231 9479-0 | info@extra4software.de | www.extra4software.de

